

Digital LCD Stereo Measuring Microscope

BLM-340M

User's Manual



This manual is written for Industrial LCD Microscope BLM-340M. For safety and for exerting the best performance, making you familiar with the instrument entirely, it is strongly recommended that you read this manual carefully before using the microscope.

Contents

Use Notices

1. Name of Components	4
2. Adjust&Operation	5
2.1 Installation	5
3. Installation and Operation of Image Tester	17
4. Maintenance	22
4.1 Maintenance of LCD microscope	22

Use Notices

BLM-340M LCD microscope has renovated the traditional way of microscopic observation and adopted a modern way of electronic imaging. Options for accurate 10x-75x magnification range. This patented microscope makes the observation more comfortable and thoroughly resolves the fatigue caused by using a traditional microscope at work for a long time. It features high resolution of LCD display to preview genuine imagings. This unit integrates magnification, imaging, display and built-in LED illumination functions. It can be conveniently applied to testing and inspecting in product assembly, research and teaching fields.

I. Safety note

- 1. Carefully open the box, avoid the accessories, dropping to ground and being damaged.**
- 2. Do keep the instrument out of direct sunlight, high temperature or humidity, dusty and easy shaking environment. Make sure the stage is smooth, horizontal and firm enough.**
- 3. When moving the instrument, please use two hands to grip with the two sides of the microscope body.**
- 4. Make sure the instrument is earthed, to avoid lighting strike.**
- 5. Check the input voltage: be sure the input voltage which signed in the below of the microscope is consistent with the power supply voltage, or it will bring a serious damage to the instrument.**

1.Name of Components

1.Components

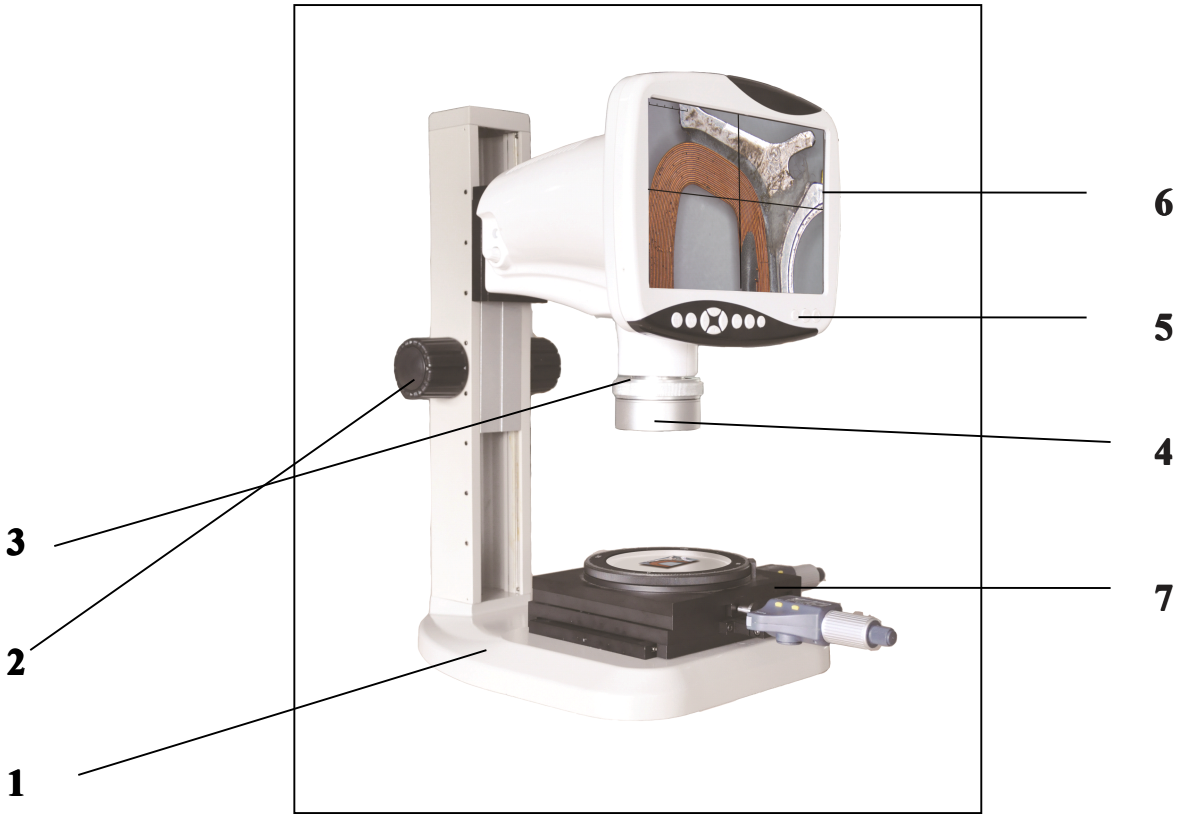

1. **Base**
2. **Focus adjusting hand wheel**
3. **Continual zooming**
4. **LED Ring lamp**
5. **Operation button layout**
6. **LCD Screen**
7. **Measuring stage**







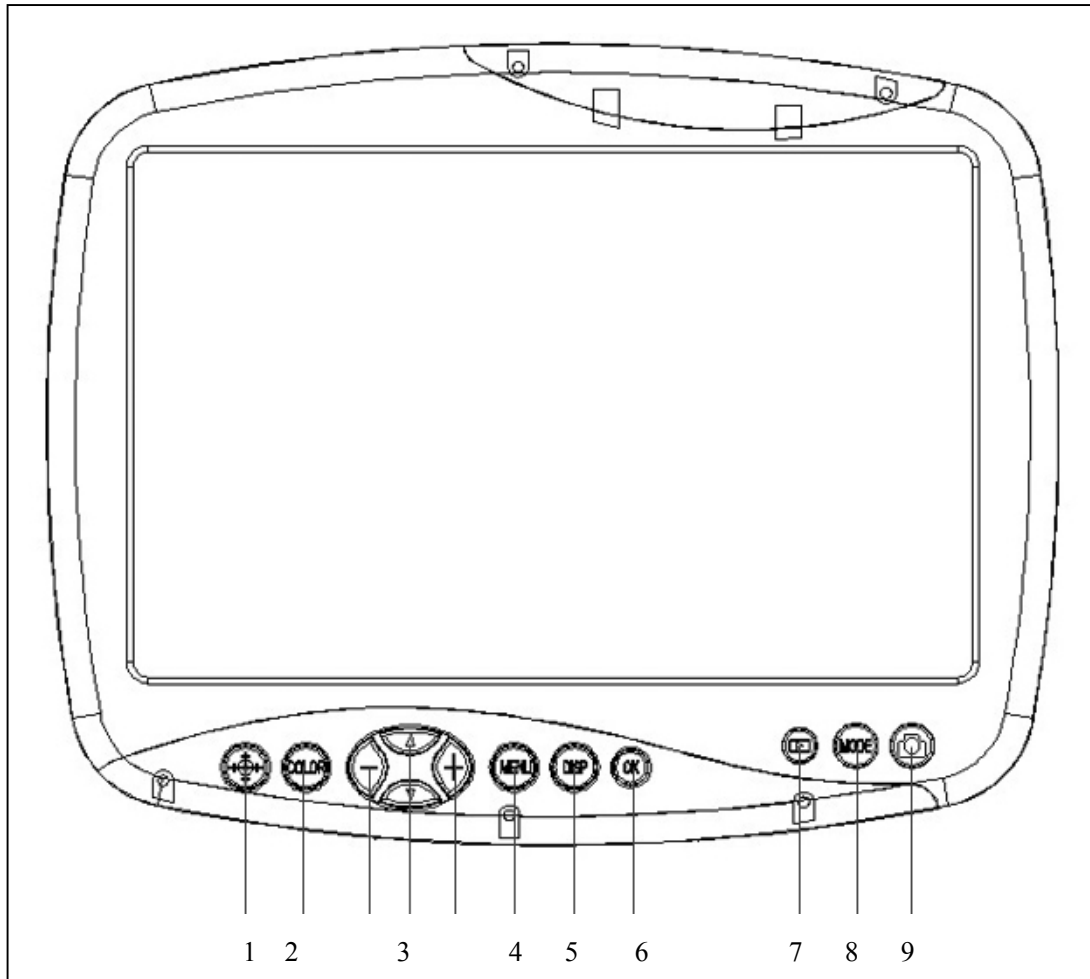

Based on the model you have purchased, some of the features shown above may change.

2. Adjustment & Operation

2.1 Operation buttons and function



2.1.1 Operation buttons and functions

- | | |
|---|---|
| 1、  Crosshair & Coordinate | 6、  Confirm Button |
| 2、  Color: White、 Black、 Red、 Purple、 Green | 7、  Snapshot & Video Playback View |
| 3、  Direction key | 8、  Snapshot & Video Switch |
| 4、  Menu: Setting & Exit | 9、  Snapshot & Video |
| 5、  Display button: Only display image and remove kinds of characters, symbols | |

2.1.2 Power on

A. Before power on, please take out the SD card from the card reader firstly. Insert SD card into SD slot in the right of the microscope head completely until it is locked. Push softly the inserted SD card, it will eject out, then take it out (When the card is under reading or writing, do not pull it out. Better power off first before pulling out the SD card).

B. Connect the DC plug of the power adapter to the “DC” jack on the the microscope. Press the power switch  on microscope base, “WELCOME” should appear on the LCD screen. After 3 seconds, the microscope system will be in the preview in the real time automatically when you can snap.

C. Adjust microscope’s definition: according to its imaging focal length, make images sharp from LCD display screen, and then the adjustment is done.

2.1.3 Introduction of display on the LCD screen

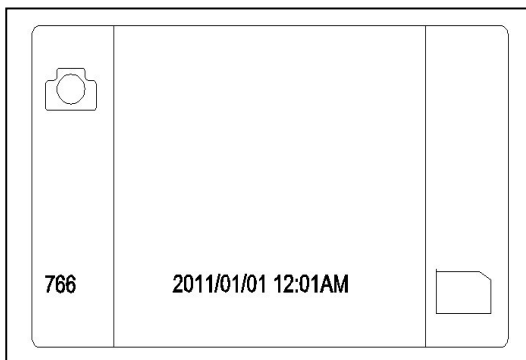

Fig.1

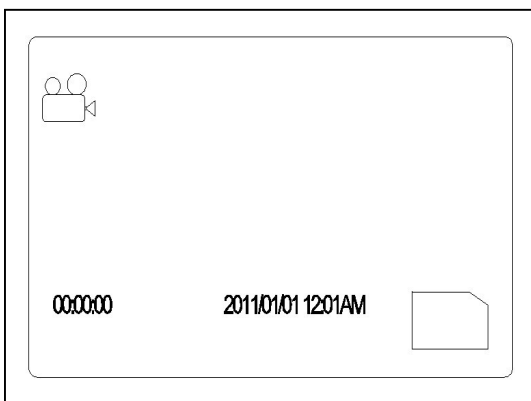



Fig.2

Icons of upper left corner of Fig.1 and Fig.2

( & ) indicate snap(photo) mode and video mode.

On the snap mode:

Shown on the below left corner is the Nos of photos that can be taken or the video recording time (“766” means in the current setup mode, it still can shoot 766pcs photos) Fig.1. (“00 : 00 : 00” means in current setup mode it still can record 00min 00sec)

Fig.2.

When you insert SD card, the below right corner will show this mark  .

2. 1. 4 Function menu control

With the help of the  button, it is able to carry out the setting of the whole system. The direction key

 allows you to choose the following functions:

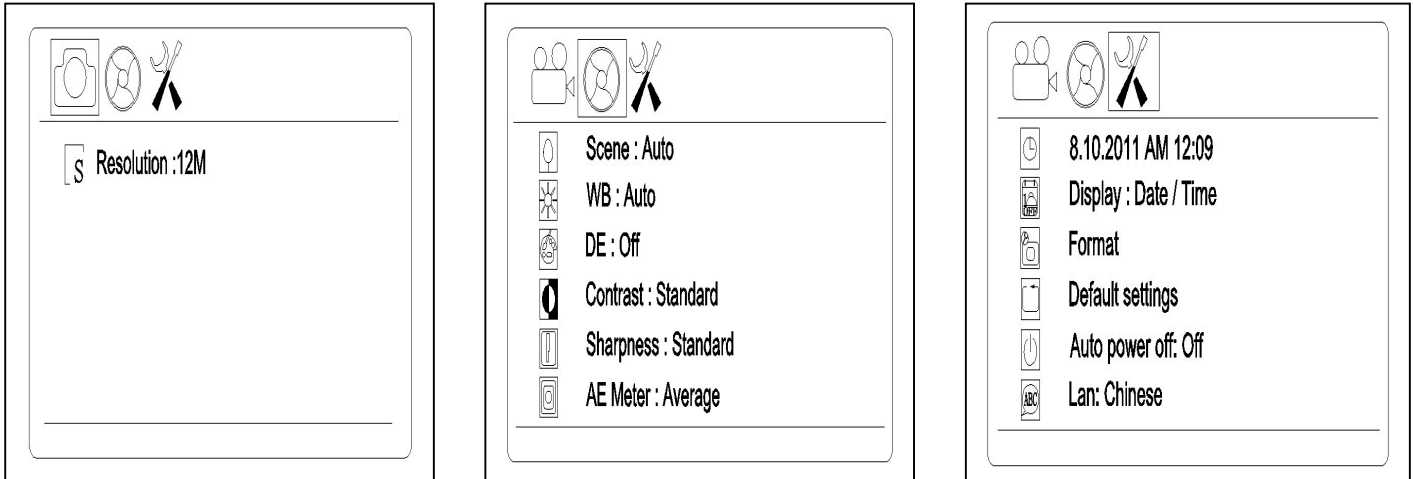



Fig.3

On the snap model,press  menu button to enter menu interface. Use direction key to select a setting from the above 3 items.
A: Resolution / B: Camera function setting / C: Display setting/

A. Photo Resolution

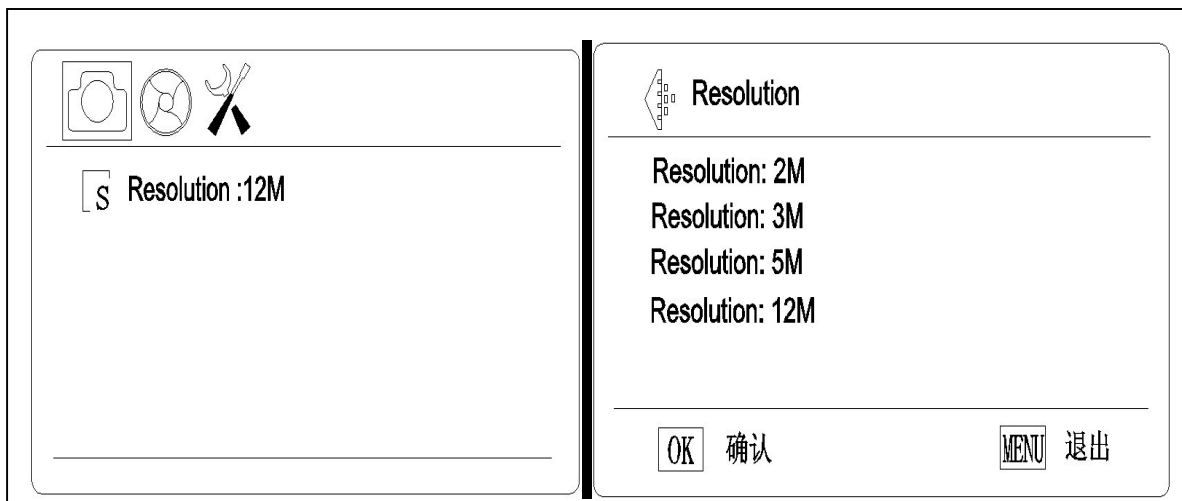







Fig.4

Select photo resolution

On snap model, press **MENU**  button as shown the “Resolution:12M”(12M means the pixels has selected now), then press the **OK**  key to select the pixels for photo taken base on 2M/3M/5M/12M use by up & down keys  (**Fig.11**). Press **OK**  button to save your selection, the model comes back to **Fig.10**.then you press **MENU**  button again, the model comes back to snap model.

A. Video Resolution

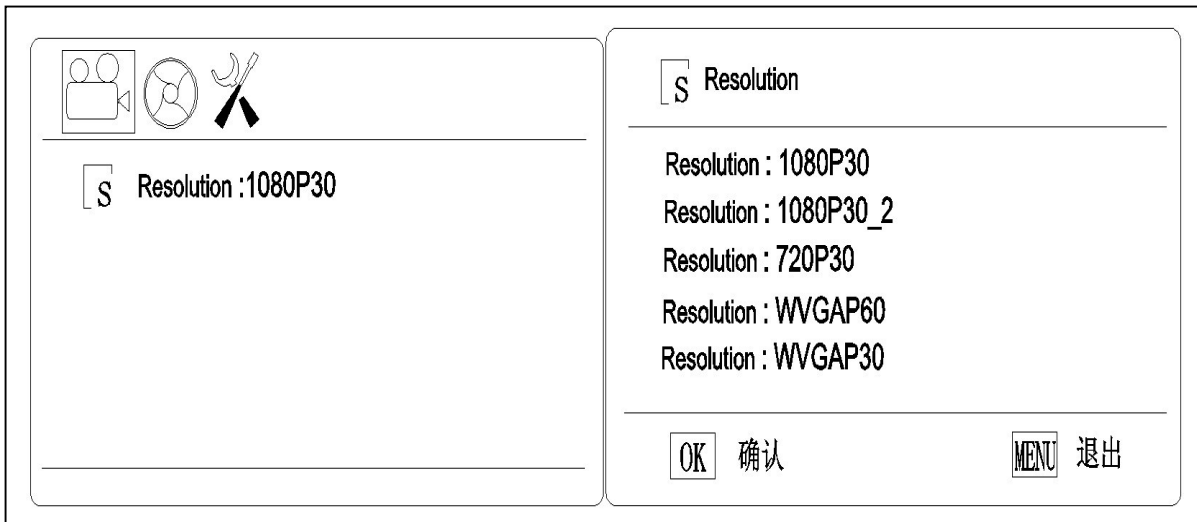







Fig.5

Fig.6

Select video resolution

On video model, press **MENU**  button as shown the “Resolution:1080P30”(1080P30 means the pixels has selected now), then press the **OK**  key to select the pixels for video taken base on 1080P30/1080P30-2/720P30/ WVGAP60/WVGA P30 use by up & down keys  (**Fig.6**). Press **OK**  button to save your selection, the model comes back to **Fig.5**.then you press **MENU**  button again, the model comes back to video model.

B. Camera function setting

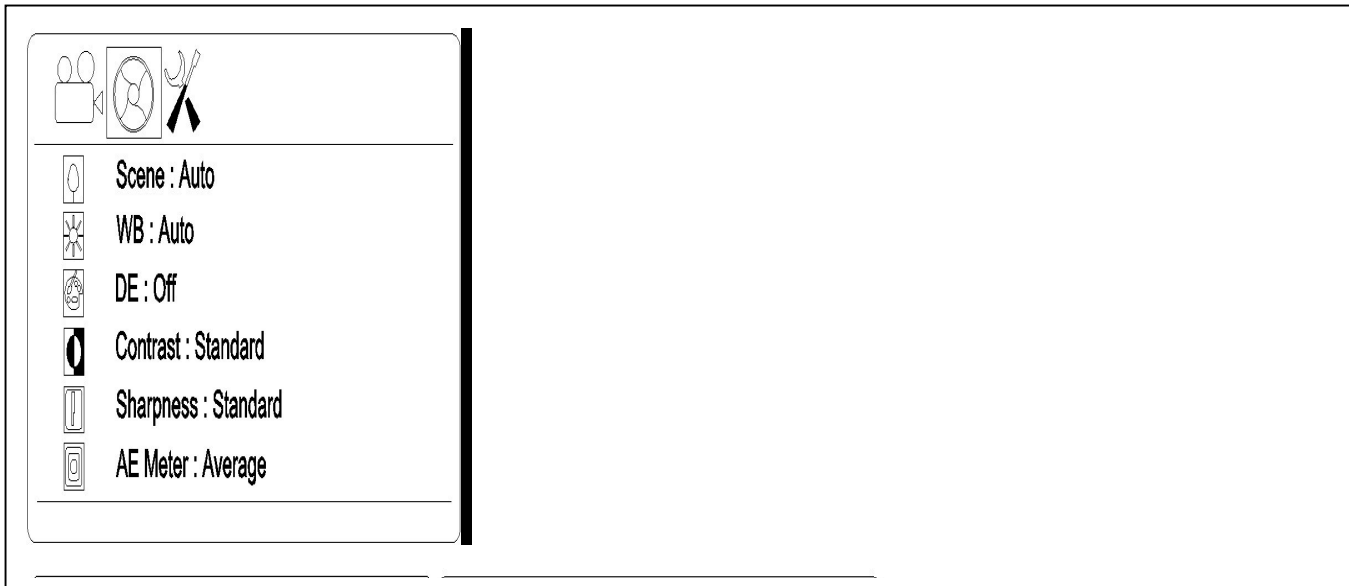







Fig.7

Fig.8

Fig.9

Camera function setting: Setting up each item.

On snap model, press  **MENU** button as show the “Resolution”, then press the left & right key to enter the “Camera Function Setting”  (**Fig7**). Then press up&down key to select as Scene/ WB/ DE/ Contrast/ Sharpness/ AE Meter/ AE ISO/ AE Bias. (**Fig.7&8**). For example: **Fig.7** You can press the **OK**  key to enter the Scene setting and choose by up & down keys (**Fig.9**). Press **OK** button  again to save your selection or exit by  **MENU** button. Once confirmed, the model comes back to **Fig7**, press  **MENU** again, you can come back to snap model .

On video model, the operation is same.

C. Display setting

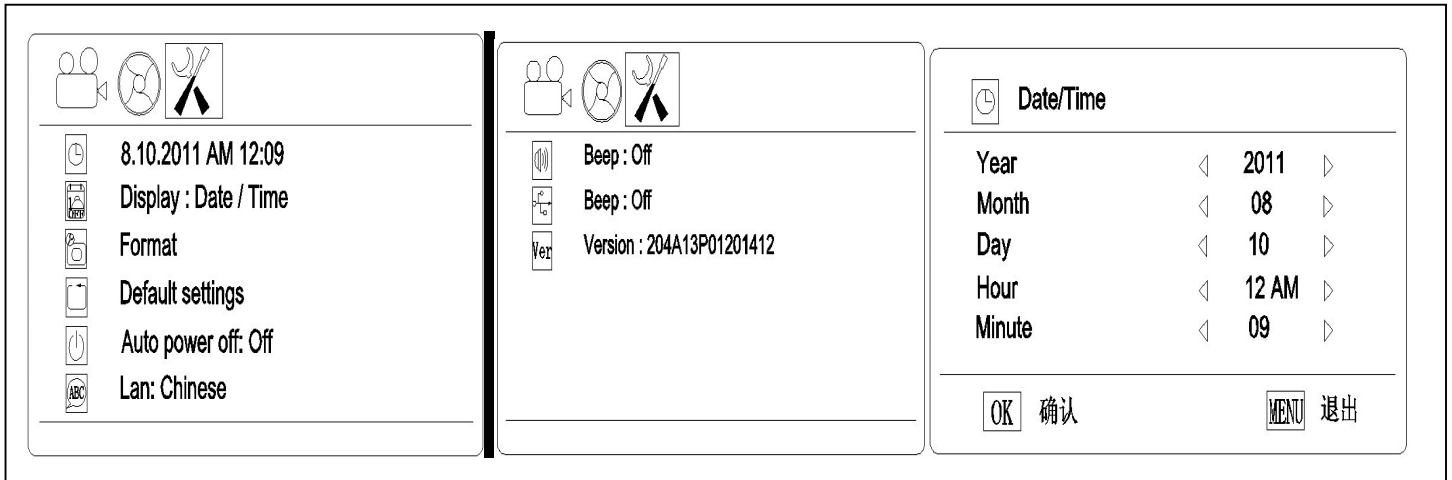







Fig. 10

Fig. 11

Fig. 12

Display Setting: Setting up each item.

On snap model, press  **MENU** button as show the “Resolution”, then press the left & right key to enter the “Display Setting”  **(Fig10)**. Then press up&down key to select as Date/Time、Display、Format、Default settings、Auto power off、Languge、Beep、USB、Version. **(Fig.10&11)**. For example: **Fig.17** You can press the **OK**  key to enter the Date/Time setting and change by direction keys **(Fig.12)**. Press **OK** button  again to save your selection or exit by  **MENU** button. Once confirmed, the model comes back to **Fig10**, press  **MENU** again, you can come back to snap model. On video model, the operation is same.

2. 1. 5 Camera function setting details

A Scene

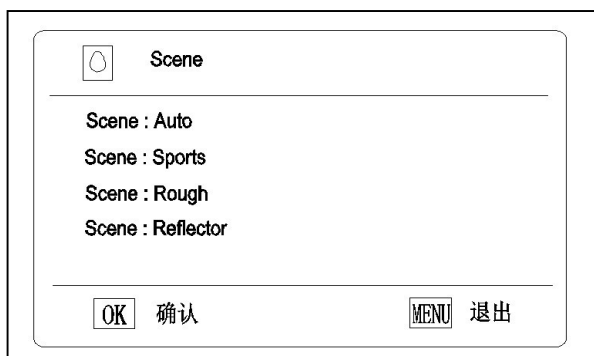

You can choose different Scene by **MENU** button according to the objects observed so that help you to get perfect performance.

B. WB (White Balance)

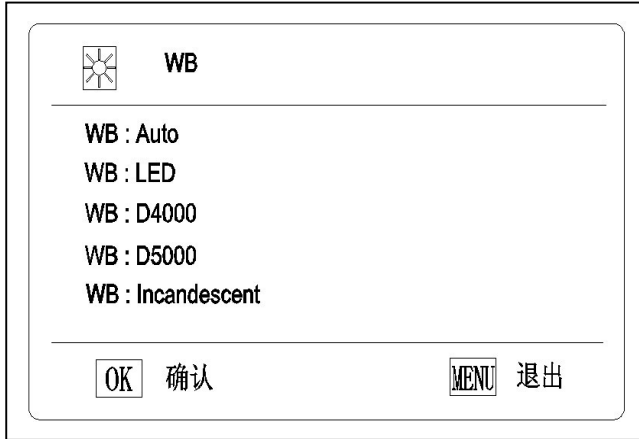

WB will help you to obtain superb color when observing.

C DE (Color effects)

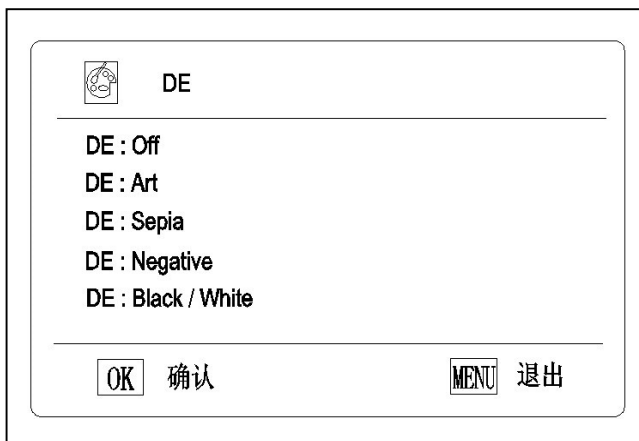

D. Sharpness

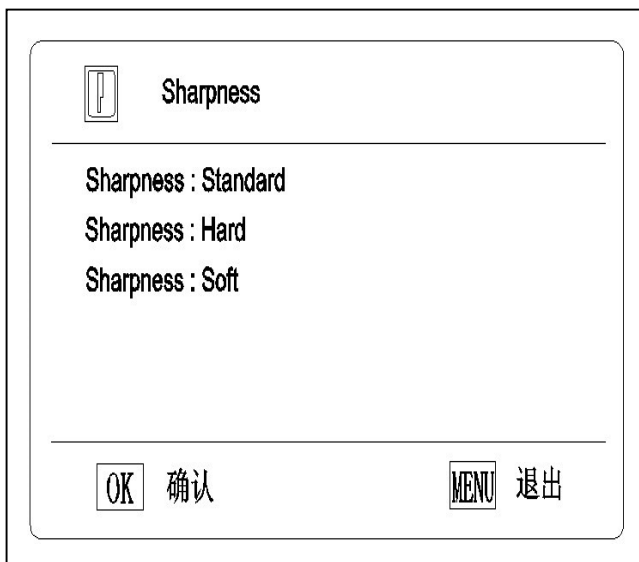

E. AE Meter

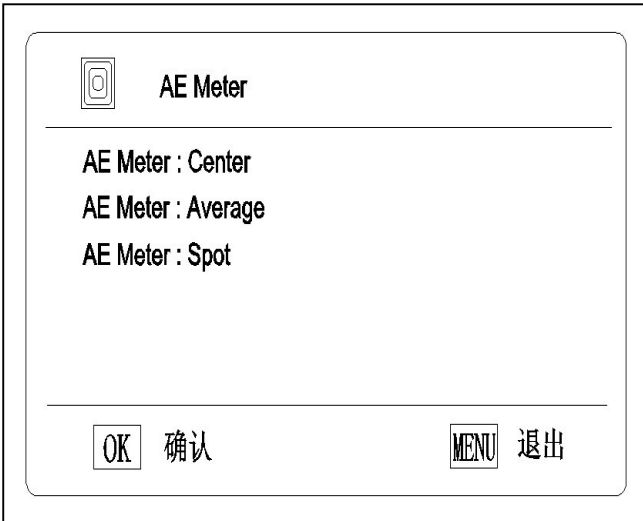

F. AE ISO

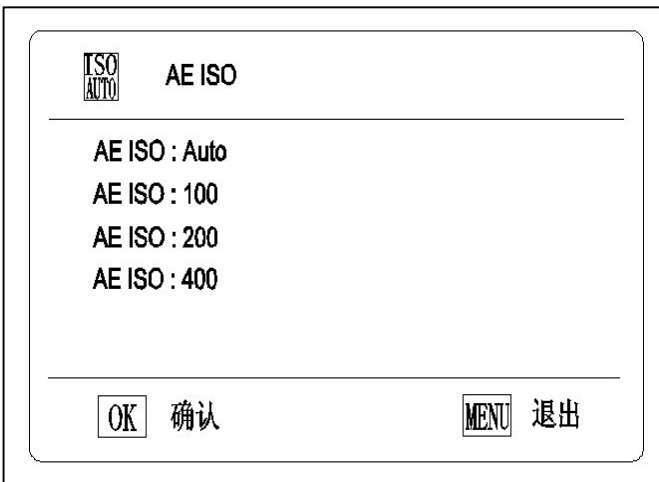

G. AE Bias

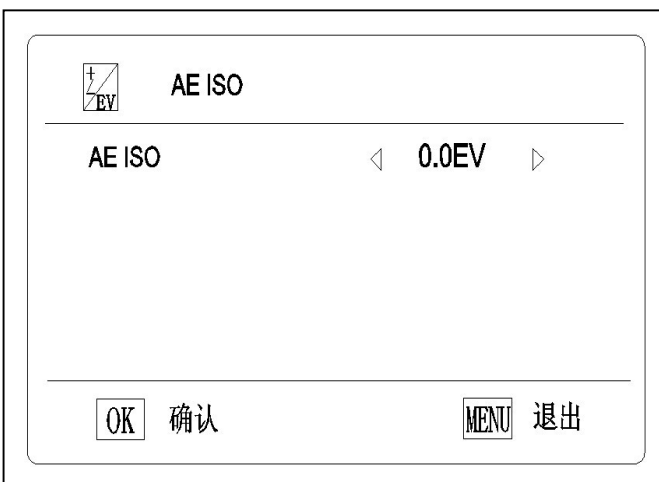

2. 1. 6 Display setting details

A. Date/Time

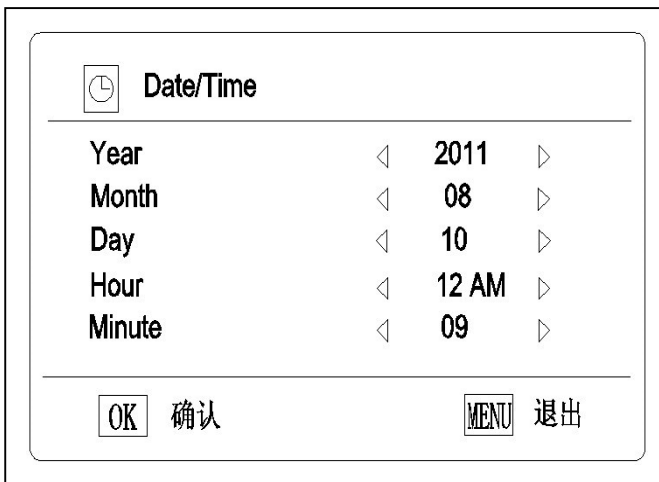

You can use left and right keys of direction button to change the time. After fixed, you can save the time.

B. Display

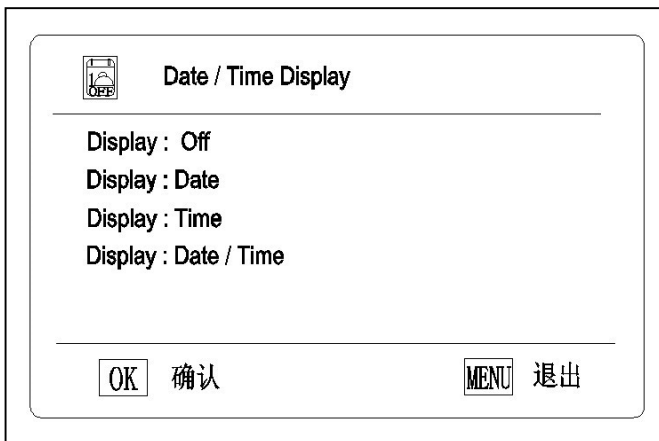

Date and time information can be stored together with photo taken in SD card. File names also contain date and time information. Before using this camera, please set the date and time properly. You can choose what display you want. If you want to display “Date”, you can choose the second option.

C. Format

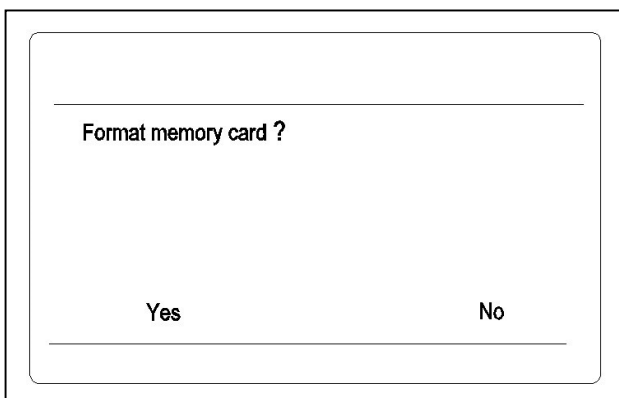

Select “Yes” can format all the SD card inserted; (Attention: Even the protected content will be deleted)

when formatting, can not be resumed again.) Select “No” and press menu button , the model comes back to the snap model.

D. Reset system settings to default values ?

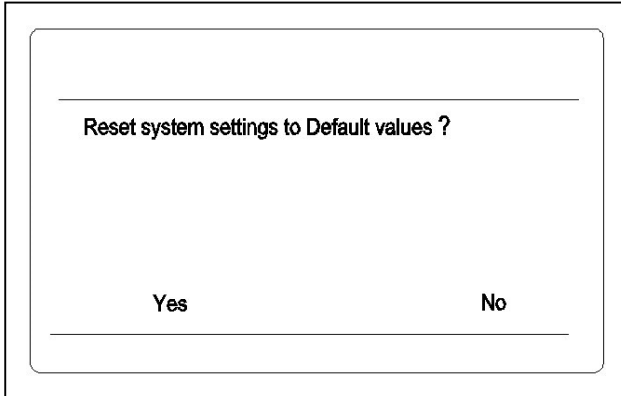

E. Auto power off

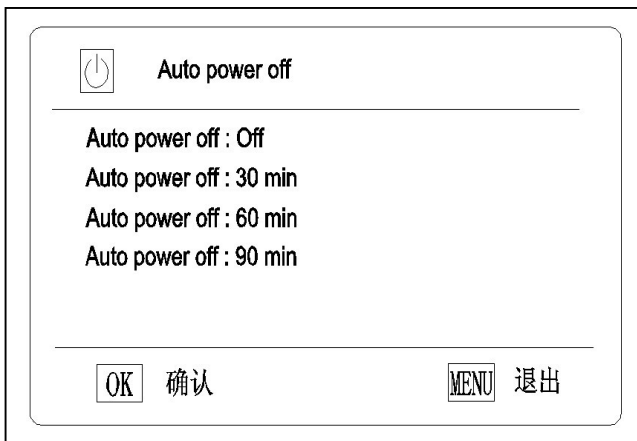

F. Langue



We developed 9 languages according to your demand.

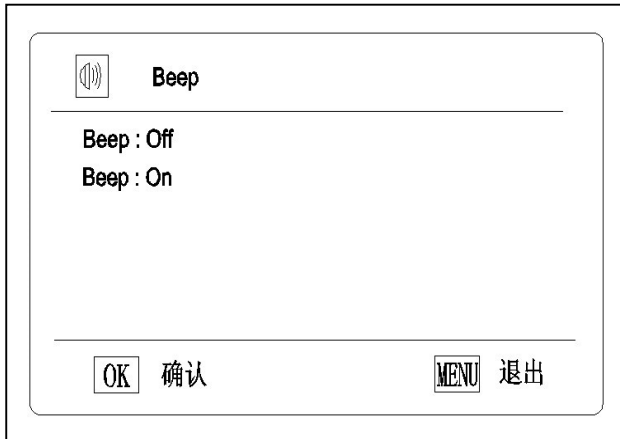

G. Beep



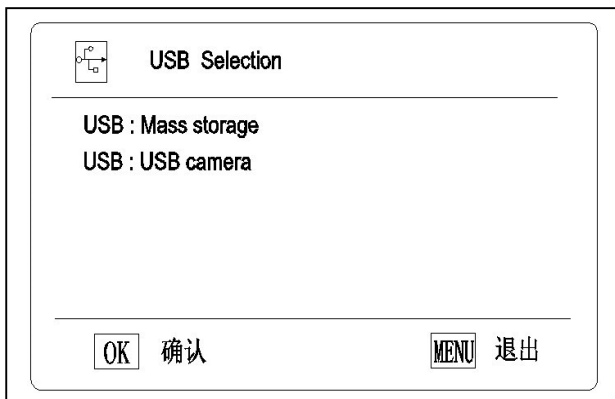



H. USB Selection



2. 1. 7 Snapshot & Record

A. Snapshot On the snap model, press  button to snapshot pictures and meantime  icon of upper left of LCD screen will show. The pictures automatically stored in SD card. When the card is full, the LCD screen will show “Card full”

B. Record On the snap model, you can enter video model by pressing  button. Meantime the image will show full screen and you can press  button to start recording and  will show on the LCD screen. Press  button again, the video is over and automatically stored in SD card . When the card is full, the LCD screen will show “Card full”

C. Playback Press  button to select playback model.

Press up & down keys to browse every photo and video which is taken and stored in the SD card.

Press left key, the screen will display multi photos and videos. Index display helps to find target photo or video quickly in many pictures and videos.

On the snap model, you can review pictures but can't review videos.

On the video model, you can review videos but can't review pictures.

3. Installation and Operation of Image Tester

A. Installation of image tester:

1. Installation method and steps of the micrometer:

★ Plug ② support rod of micrometer into ① movable platform clamp spring first, with the LCD screen facing upward, and noting that the support rod of micrometer should be plugged to location. Then, use M3 inner hexangular spanner to tight uniformly the fastening screw for the rod of micrometer to the extent of not shedding off and rotating the micrometer.

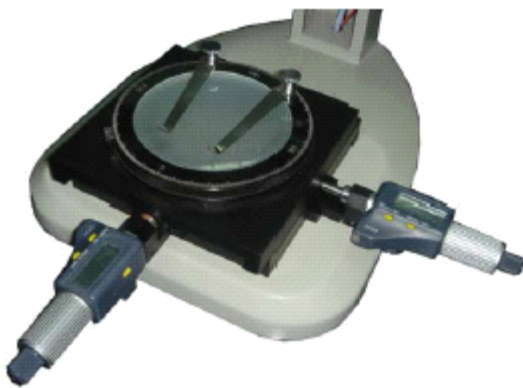
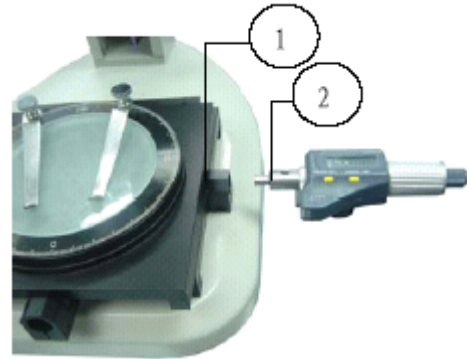

★ Install another micrometer in the same way and steps to the movable platform clamp spring. Tighten the fastening screw to clamp the support rod of micrometer to the extent of not shedding off and not rotating. Put it into the black/white workbench or single sided frosted glass workbench (note that the smooth surface should be facing upward). The final installation structure is as shown in the diagram.

2. The instructions for installation method and application of the system are referred to DMS100 user manual.

B. The connection and application of bed light source:

★ The connection of bed light source: Connect one end of the connection line with the both ends having spring and normal DC specification to the DC socket marked with "DC OUT", with another terminal inserting into the DC socket of the frame



Image Tester



★ Adjust the black knob at the right side of column for the brightness of bed light source, attaining the sharp image outline. The arrowhead direction is the rotating direction for increasing brightness. The reverse direction is for brightness attenuating and turning off the bed light source power.

C. Operating instructions for the measurement application of image tester:

★ The measurement of length:

1. Place the system levelly on a desktop. Firstly, install and fasten the micrometer and the movable platform, wipe clean the workbench surface, connect properly the DC connection line of bed light source, and connect the main system power supply.
2. Press lightly the main system power switch, start the instrument and rotate the rapid driving device of micrometer so that the screw rod of the micrometer stretches out about half of length (12.5mm). Place the substance to be measured lightly on the center of workbench surface, with the bed light source available to shine thoroughly for the best.
3. Adjust the focal length, magnification and the brightness of the upper light source and the bed light source, making the substance to be measured having a very sharp image.
4. Self define the linear graphic, rotate the rotary disc of the rotation movable platform, so that one side of the substance tested runs parallel with the cross line. Rotate again the rapid driving device of micrometer to align closely one side of the substance tested with the cross line. Reset the micrometer. Rotate the rapid driving device to align closely the position to be measured with cross line of one side of the aligned substance. The value of the micrometer is the value of the substance value measured.

Remarks: The detail application of the micrometer is referred to the operation manual of the electronic micrometer

Operation Manual of Electronic Micrometer

1. Sketch diagram of structure:

Image Tester

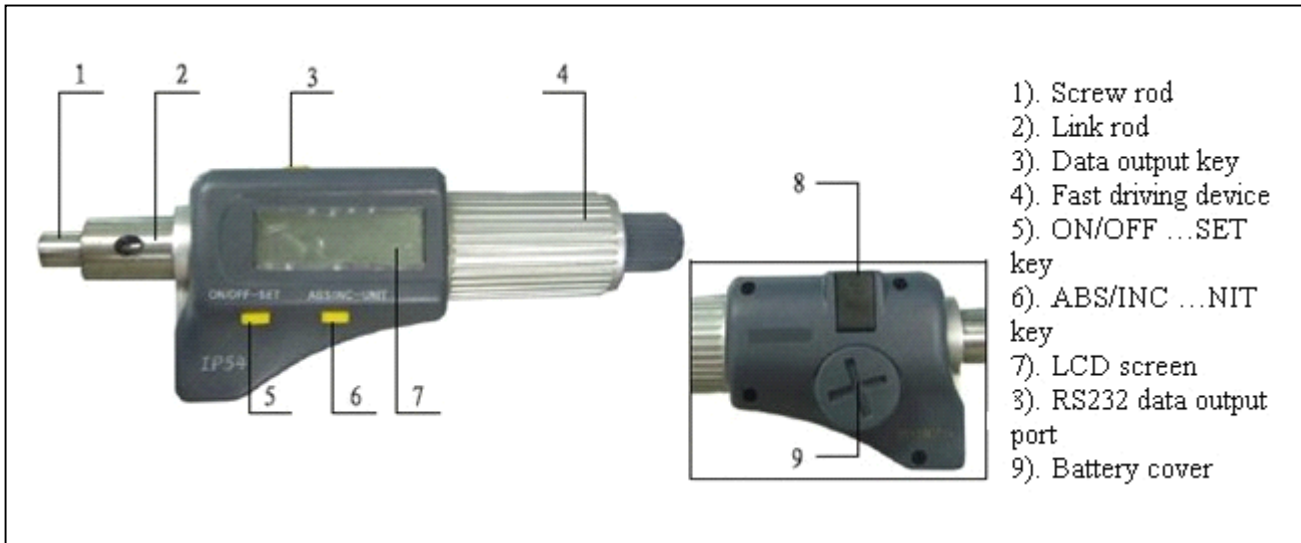

2. LCD screen:

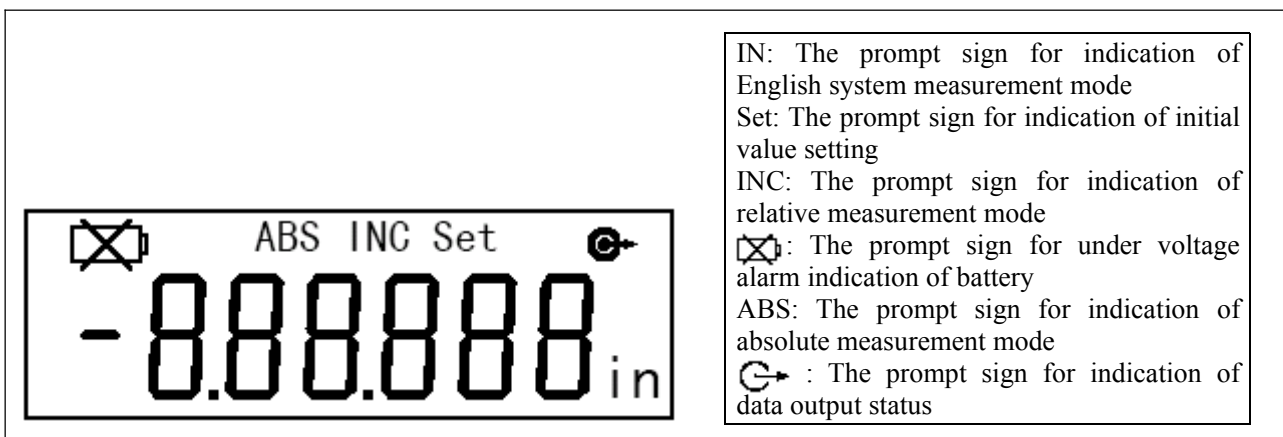

3. The function and operation of the key:

There are two kinds of key operation:

(1) Short press (time < 2 seconds)

(2) Long press (time ≥ 2 seconds)

3. 1. ON/OFF ... SET: The switch key, delay setting key

The key operation < 2 seconds: Power supply ON/OFF of digital display meter

The key operation ≥ 2 seconds: Setting initial value of digital display meter of absolute measurement: Display "Set".

The initial values of digital display meter of different measuring range are respectively 0, 25, 50 ... 275 mm under the metric system mode;

The initial values of digital display meter of different measuring range are respectively 0, 1", 2" ... 11" under

Image Tester

the English system mode.

After reinstalling a battery, the initial value setting will be carried out automatically.

The default initial value of the digital display meter is 0.

3. 2. ABS/INC ... UNIT: Absolute/relative measurement mode convert key, the delay metric system/English system to measurement mode convert key.

The key operation <2 seconds: Absolute and relative measurement mode convert:

Relative measurement mode with "INC" indication, absolute measurement mode with "ABS" indication.

The key operation ≥2 seconds: Metric/English system convert: The English system measurement mode with "in" indication, otherwise it is the metric system measurement mode.

3.3. The data output key:

The key operation < 2 seconds: It will deliver output once, and it will display on the LCD screen once as " ↻ ".

Continuous key operation ≥ 2 seconds: It will deliver output display data continuously, and the LCD screen displays continuously " ↻".

The output data will be ended if you press this key again.

4. Power supply:

- **Digital display meter adopts one SR44 battery. Please replace the battery when the digit displayed on LCD screen is unclear or when displaying "⊠".**
- **The digital display meter will cut off the power automatically if the digital display meter is not used for 5 minutes and it will resume to the original value prior to the auto cutting off if rotating the screw rod or pressing "ON/OFF ... SET" key. Please press "ON/OFF ... SET" key to turn off the power supply for energy saving if it is not to be used.**
- **Insert a coin to the slot on the battery cover and rotate clockwise to lose and open the battery cover. Take out the used battery.**
- **Change for a new battery with the positive polarity heading up. Screw tightly the battery cover anti-clockwise.**

5. The data output:

- **The data output is of the standard RS232 C format, and can be connected to the serial PC port via**

Image Tester

cable.

6. Precautions:

- **Do not fall off or collide the digital display meter and do not apply too great a force.**
- **Do not dismantle the digital display meter.**
- **Do not press the key with a sharp object. To press a key, please move along the moving direction of the key, otherwise, it will affect the sensitivity of key.**
- **Please do not use or store the digital display meter at a location with direct sunlight, or an environment too cold or too hot.**
- **Please do not use the digital display meter in an environment with too high voltage or strong magnetic field.**
- **The dry soft cloth or cotton may be used to wipe the stains on the surface of digital display meter. Do not use organic solvent such as acetone or benzene to clean the meter.**
- **Use soft cloth to wipe the measurement face before measurement.**
- **Please take out the battery if the meter is not to be used for a long time.**

7. Characteristics:

Measurement of force: 5-10 N measuring range: 0-25 (the present product supplied) resolutions: 1 μ m

Power consumption: $\leq 35 \mu$ A operation temperature: 0-40°C storage temperature: -20 - 60°C

4.Maintenance

4.1 Maintenance of LCD microscope

For the sake of good microscope protection, it is required to avoid dust, water and humidity intruding into the instrument, otherwise, the photo route and the electronic circuit of microscope might be damaged. Moreover, the apparent grease spot, finger print on the surface of optical kit, dust, dirt stains will effect the imaging quality.

When the microscope is not in use, the microscope should be covered with a clean sheath timely to prevent dust from entering in.

The product is suitable for application and storage indoor, with the environ-mental humidity for operation and storage being 30%—80%. The environmental temperature for operation and storage being 0℃—40℃.

Optical section

The lens should be stored in a dry environment, and it is available to place it in a container with drier agent.

If the surface of lens is attached with dust, please use an air blower ball to clear it off.

If the surface of lens is attached with finger print, dirt, greasy stain or other trace not available to use an air blower ball to clean, please use absorbent cotton or lens paper dipped with a little alcohol or ether mixture (proportion 1:4) to wipe off them lightly.

Notice: Under no any circumstances should the lens surface be dry cleaned, otherwise the surface of lens may be damaged. Moreover, it is not allowed to wipe the lens with water or other liquid solutions.

LCD screen

It is required to pay attention that no heavy pressure on the surface of color LCD screen is allowable during operation and storage.

In case the LCD screen surface is dirty, it is only available to use clean and soft cloth to wipe lightly, and it is forbidden to use organic solution agent to wash and clean.

It is forbidden for the consumers to disassemble the microscope by themselves, least there is danger of damage or electric shock.